

## Paramagnetic Transition-metal Carbonyls. Part 6.<sup>1</sup> Derivatives of Di-carbonyl( $\eta^5$ -cyclopentadienyl)cobalt(I)

By Martyn C. R. Symons \* and Stephen W. Bratt, Department of Chemistry, The University, Leicester LE1 7RH

Exposure of solutions of the title complex  $[\text{Co}(\text{cp})(\text{CO})_2]$  to  $^{60}\text{Co}$   $\gamma$ -rays at 77 K has produced a radical identified as the parent anion by its e.s.r. spectrum. Electron addition has been confirmed by photoionisation of the electron source *NNN'*-tetramethyl-*p*-phenylenediamine. Analysis of the  $^{59}\text{Co}$  hyperfine structure and *g*-tensor components suggests a  $d^{1, z}$  structure, where *z* bisects the OC-Co-CO angle and *y* lies in the OC-Co-CO plane. This  $\sigma^*$  orbital is well removed from the remaining filled *d* orbitals. In methanolic solutions, and on annealing a methyltetrahydrofuran (mthf) solution above 77 K, a second species, with similar magnetic properties but exhibiting an extra 13 G doublet splitting, is also observed. This extra splitting is assigned to hyperfine coupling with a single proton, probably attached to one of the carbonyl groups. Other spectra observed in solutions and in the pure solid are attributed to the parent cation and to a dimeric cation respectively. The results for the anion are compared with solid-state data for the dimer anion  $[\{\text{Co}(\text{cp})(\text{CO})\}_2]^-$  and its isoelectronic analogue  $[(\text{cp})\text{Co}(\text{NO})(\text{CO})\text{Co}(\text{cp})]$ , both previously studied only in the liquid phase. Our results for these dimers show that the two cobalt atoms are identical in the solid state, that the extra electron is in a  $\pi^*$  orbital having *ca.* 77% cobalt character, and that reduction to the dimer proceeds *via* the parent anion. A stable trimeric cobalt radical is formed when  $[\text{Co}(\text{cp})(\text{CO})_2]$  in mthf solution is  $\gamma$ -irradiated at room temperature.

We have recently shown that the technique of low-temperature radiolysis, which often results in the formation of low concentrations of electron-gain and -loss centres which remain trapped in the rigid media, can be applied to the preparation of paramagnetic derivatives from transition-metal carbonyl compounds.<sup>1</sup> This approach has now been applied to the  $\eta^5$ -cyclopentadienyl (cp) derivative  $[\text{Co}(\text{cp})(\text{CO})_2]$ .

The photochemistry of  $[\text{Co}(\text{cp})(\text{CO})_2]$  has been widely investigated. King reported<sup>2</sup> that prolonged u.v. irradiation in hexane at room temperature produced two separable isomers of a trimer,  $[\{\text{Co}(\text{cp})(\text{CO})\}_3]$ . A somewhat similar reaction yielded<sup>3</sup> the metal-oxygen cluster  $[\text{Co}_3(\text{cp})_3(\text{CO})\text{O}]$ , whereas exposure in benzene generated<sup>4,5</sup> the binuclear complex  $[\text{Co}_2(\text{cp})_2(\text{CO})_3]$ , which can react further to form  $[\{\text{Co}(\text{cp})(\text{CO})\}_3]$  and a tetramer  $[\text{Co}_4(\text{cp})_4(\text{CO})_2]$ . By photolysing at 195 K, Lee and Brintzinger<sup>6</sup> were able to identify the intermediate  $\text{Co}(\text{cp})(\text{CO})$  by its i.r. spectrum and to demonstrate its ability to dimerise to  $[\{\text{Co}(\text{cp})(\text{CO})\}_2]$ .

In contrast<sup>7</sup> to other simple  $\eta^5$ -cyclopentadienyl metal carbonyls, reduction of  $[\text{Co}(\text{cp})(\text{CO})_2]$  by sodium in tetrahydrofuran (thf) or in hexamethylphosphoramide (hmpa) yields a binuclear radical anion sufficiently stable to be isolated as the salt  $[\text{N}(\text{PPh}_3)_2][\{\text{Co}(\text{cp})(\text{CO})\}_2]$ . The crystal structure and e.s.r. spectrum in solution have been reported.<sup>8-10</sup> This anion is isoelectronic with  $[(\text{cp})\text{Co}(\text{NO})(\text{CO})\text{Co}(\text{cp})]$ ,<sup>11</sup> which has also been studied in solution by e.s.r. spectroscopy.<sup>12,13</sup>

Negative ions derived from  $[\text{Co}(\text{cp})(\text{CO})_2]$  have been studied by gas-phase ion cyclotron resonance spectroscopy.<sup>14</sup> Both  $[\text{Co}(\text{cp})(\text{CO})_2]^-$  and  $[\text{Co}(\text{cp})(\text{CO})]^-$  are observed and it is postulated that  $[\text{Co}(\text{cp})(\text{CO})]^-$  reacts with a neutral molecule to form  $[\{\text{Co}(\text{cp})(\text{CO})\}_2]^-$ .

### EXPERIMENTAL

Dicarbonyl( $\eta^5$ -cyclopentadienyl)cobalt(I) was obtained from Strem Chemicals Inc., Danvers, Massachusetts, and distilled before use. The bis( $\mu$ -carbonyl- $\eta^5$ -cyclopentadienyl)cobaltate(*Co-Co*) radical anion  $[\{\text{Co}(\text{cp})(\text{CO})\}_2]^-$  was

generated by distilling  $[\text{Co}(\text{cp})(\text{CO})_2]$  into a quartz e.s.r. tube containing a degassed solution of sodium in hmpa or thf on a vacuum line. When evolution of carbon monoxide had ceased, the tube was sealed under vacuum. The isoelectronic compound  $\mu$ -carbonyl- $\mu$ -nitrosyl-bis( $\eta^5$ -cyclopentadienyl)cobalt(*Co-Co*) was prepared by treating a 2-methylbutane solution of  $[\text{Co}(\text{cp})(\text{CO})_2]$  with nitrogen monoxide gas at 147 K substantially according to the method of Herrmann and Bernal.<sup>12</sup> A mixture of the two isomers of  $[\{\text{Co}(\text{cp})(\text{CO})\}_3]$  was synthesised by King's procedure.<sup>2</sup> They were not separated. *NNN'*-Tetramethyl-*p*-phenylenediamine (tmpd) was vacuum sublimed prior to use. All the solvents employed were of the highest available grade.

Solution samples were prepared by distillation into 4 mm O.D. (outside diameter) silica tubes, followed by several degassing cycles and sealing *in vacuo*. They were exposed to  $^{60}\text{Co}$   $\gamma$ -rays in a Vickrad source at a dose rate of *ca.* 1.6 Mrad h<sup>-1</sup> for periods of up to 5 h.† Samples were photolysed at 77 K in a quartz Dewar with a high-pressure mercury u.v. source.

E.s.r. spectra were recorded at *X*-band on a Varian E109 spectrometer and at *Q*-band on an instrument previously described.<sup>15</sup> For *X*-band measurements at 77 K the samples were held in a quartz Dewar inserted into the e.s.r. cavity. For studies above 77 K the liquid nitrogen was decanted and the spectrum continuously monitored as the temperature rose. The sample was recooled to 77 K whenever significant changes occurred. The *X*-band spectra were calibrated with a Hewlett-Packard 5246L frequency counter and a Bruker BH12E field probe, which were regularly standardised with a sample of diphenylpicrylhydrazyl (dpph).

### RESULTS AND DISCUSSION

A cobalt-centred radical (A) was detected when  $[\text{Co}(\text{cp})(\text{CO})_2]$  was  $\gamma$ -irradiated at 77 K either pure or as frozen solutions in 2-methyltetrahydrofuran (mthf), methanol, 2-methylbutane, tetramethylsilane,  $(\text{CD}_3)_2\text{CO}$ , or hmpa. This axially symmetric radical shows hyperfine structure consistent with coupling to one cobalt

† Throughout this paper: 1 rad = 10<sup>-2</sup> J kg<sup>-1</sup>; 1 G = 10<sup>-4</sup> T.

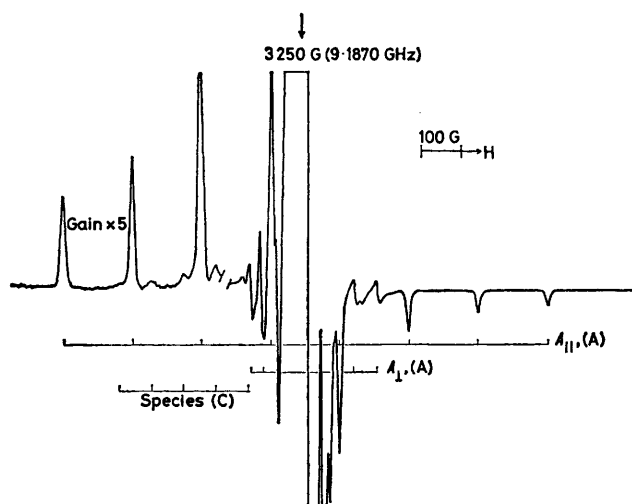

FIGURE 1 First-derivative X-band e.s.r. spectrum of  $[\text{Co}(\text{cp})(\text{CO})_2]$  in mthf solution after exposure to  $^{60}\text{Co}$   $\gamma$ -rays at 77 K, showing features for centre (A)

nucleus ( $^{59}\text{Co}$ ,  $I = \frac{7}{2}$ , 100% natural abundance) (Figure 1). The parallel components are well defined but the perpendicular lines are partially obscured by solvent

TABLE 1

E.s.r. parameters for centres (A)—(D)

Centre	$A_{\parallel}(\text{Co})/\text{G}$	$A_{\perp}(\text{Co})/\text{G}$	$g_{\parallel}$	$g_{\perp}$	$A(\text{H})/\text{G}$
(A)	172	45	2.005	2.004	
(B)	167	ca. 43	2.013	<i>a</i>	13
(C)	77 <sup>b</sup>	41 <sup>b</sup>	2.158	1.943	
(D)	38 <sup>b</sup>	<i>a</i>	2.144	<i>a</i>	

<sup>a</sup> Insufficient data available. <sup>b</sup> Experimental hyperfine coupling (not corrected for orbital magnetic contributions).

radical features and are also subject to a strong Breit-Rabi effect. Treatment of the available information yields the data in Table 1. This radical was also produced by photolysing solutions of  $[\text{Co}(\text{cp})(\text{CO})_2]$  in mthf

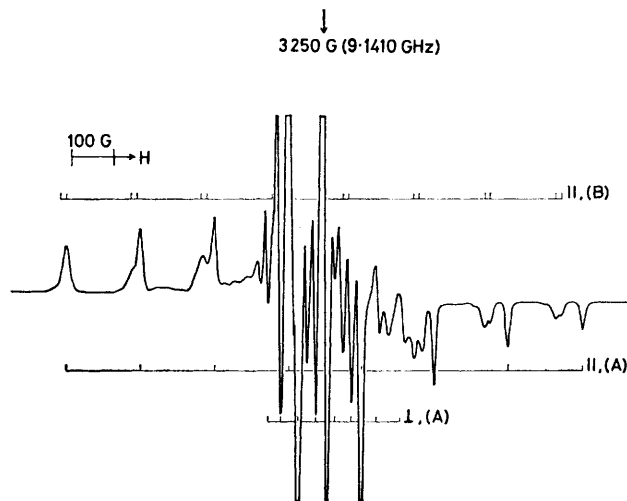

FIGURE 2 First-derivative X-band e.s.r. spectrum of  $[\text{Co}(\text{cp})(\text{CO})_2]$  in  $\text{CH}_3\text{OH}$  after exposure to  $^{60}\text{Co}$   $\gamma$ -rays at 77 K, followed by slight annealing to remove solvent radical structure, showing features for centres (A) and (B)

containing tmpd at 77 K, and we therefore suggest that (A) is the parent anion  $[\text{Co}(\text{cp})(\text{CO})_2]^-$ .

When solutions in methanol or  $\text{SiMe}_4$  were irradiated at 77 K a second monocobalt centre (B) was formed in addition to (A); this could also be produced by annealing irradiated mthf solutions above 77 K (Figure 2). It has similar parallel cobalt features to (A) but each line is split into a 13 G doublet. When solutions in  $\text{CD}_3\text{OD}$

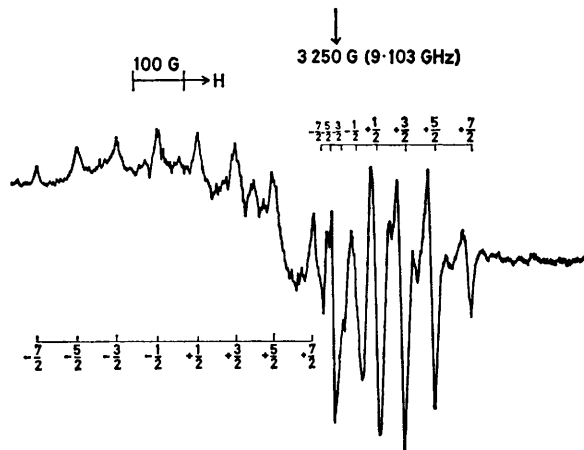

FIGURE 3 First-derivative X-band e.s.r. spectrum of  $[\text{Co}(\text{cp})(\text{CO})_2]$  in mthf after  $\gamma$ -irradiation at 77 K and followed by careful annealing to show the spectrum of centre (C)

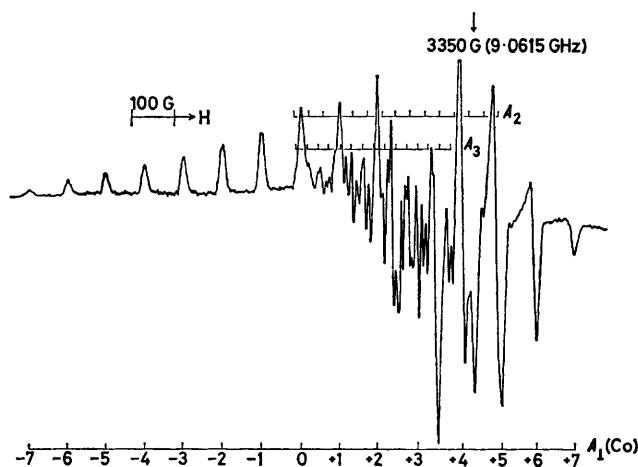

FIGURE 4 First-derivative X-band e.s.r. spectrum of  $[\text{Co}(\text{cp})(\text{CO})_2]^-$  recorded at 77 K

or  $\text{CH}_3\text{OD}$  were studied the doublet splitting disappeared, thus establishing that the splitting is caused by hyperfine coupling to a  $^1\text{H}$  nucleus. Again the perpendicular features were poorly defined because of overlap with the perpendicular components of (A) and with solvent radical features.

In  $(\text{CD}_3)_2\text{CO}$ , and in carefully annealed mthf solutions, a third monocobalt radical (C) was obtained (Figure 3). This species was also formed in poor yield in other solvents but its features were usually swamped by those of (A). A fourth radical (D) was formed in conjunction with (A) when solid  $[\text{Co}(\text{cp})(\text{CO})_2]$  was irradiated at 77 K.

The two dicobalt derivatives  $[\text{Co}(\text{cp})(\text{CO})_2]^-$  and

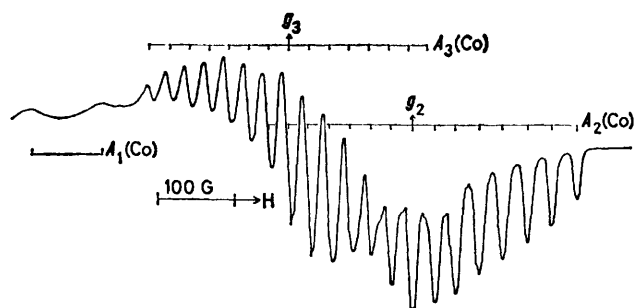

FIGURE 5 Part of the  $Q$ -band e.s.r. spectrum of  $[\{\text{Co}(\text{cp})(\text{CO})\}_2]^-$  showing the resolution of the overlapping hyperfine structure in Figure 4

$[(\text{cp})\text{Co}(\text{NO})(\text{CO})\text{Co}(\text{cp})]$  have very similar liquid-phase e.s.r. spectra.<sup>10,13</sup> The solid-state spectrum of the former at  $X$ -band (Figure 4) and at  $Q$ -band (Figure 5) has been analysed to yield the data in Table 2. Because only powder spectra have been obtained, we cannot be sure that these are principal values of the tensor components, since the  $g$  and  $A$  tensors need not share the same principal axes. (This of course also applies to the monocobalt radicals.) However, symmetry considerations suggest that this should be the case and we assume

TABLE 2

Radical	E.s.r. parameters for the dicobalt radicals							
	$A_1/G$	$A_2/G$	$A_3/G$	$A_{\text{soln.}}/G$	$g_1$	$g_2$	$g_3$	$g_{\text{soln.}}$
$[\{\text{Co}(\text{cp})(\text{CO})\}_2]^-$	-26	-34	-91	-50	2.061	2.027	2.200	2.096
$[(\text{cp})\text{Co}(\text{NO})(\text{CO})\text{Co}(\text{cp})]$	-29.1 <sup>a</sup>		-84	-47.4 <sup>b</sup>	1.978 <sup>a</sup>		2.207	2.054 <sup>b</sup>

<sup>a</sup> Estimated average. <sup>b</sup> Ref. 13.

that these are indeed principal values in the discussion below. Results for the NO derivative, also in Table 2, were less well defined, and we have only been able to obtain good parallel results.

The reduction to form  $[\{\text{Co}(\text{cp})(\text{CO})\}_2]^-$  is rapid in hmpa and no mononuclear radical is detected in the initial stages. However, reduction in thf is slower and after a few seconds reaction, followed by cooling to 77 K, the e.s.r. spectrum consists of both the dimer anion and the parent anion (A).

When  $[\text{Co}(\text{cp})(\text{CO})_2]$  in mthf is  $\gamma$ -irradiated at 300 K, a stable tricobalt radical is produced. This is also formed when  $[\{\text{Co}(\text{cp})(\text{CO})\}_3]$  in mthf is irradiated at 77 K. A detailed analysis of this result is being reported elsewhere.<sup>16</sup>

**Electronic Structures.—Centre (A).** We suggest that this centre is the parent anion  $[\text{Co}(\text{cp})(\text{CO})_2]^-$ . There are four possible sign combinations of  $A_{\parallel}$  and  $A_{\perp}$ , and four resulting values of  $A_{\text{iso}}$ , and  $2B$  (the principal value of the dipolar hyperfine coupling). The  $2B$  values can be converted into approximate  $3d$ -orbital populations by dividing by the computed value for unit occupation (calculated from the wavefunctions of Froese<sup>17</sup>), and the results are given in Table 3. We suggest that 95%  $d$  occupancy is too great for an electron in a strongly antibonding orbital, and hence favour the 55% combinations. If this is correct, the choice of positive signs for  $A$  and  $2B$  requires the unpaired electron to reside in a

TABLE 3

Possible sign combinations for the cobalt hyperfine coupling in centre (A)

Sign of $A_{\parallel}$	Sign of $A_{\perp}$	$A_{\text{iso.}}/G$	$2B/G$	% $d$ occupancy *
+	+	+87.3	+84.7	55.7 ( $z^2$ )
+	-	+27.3	+144.7	95.2 ( $z^2$ )
-	+	-27.3	-144.7	95.2 ( $\neq z^2$ )
-	-	-87.3	-84.7	55.7 ( $\neq z^2$ )

\* Using the value for unit population (calculated from data in ref. 17).

$d_{z^2}$  orbital. The large positive value for  $A_{\text{iso}}$ , then necessitates a considerable admixture of  $4s$  character to overbalance the normal negative coupling caused by spin polarisation of the inner  $s$  electrons. Alternatively, the choice of negative signs produces a value of  $A_{\text{iso}}$ , normal for an electron in any orbital other than  $d_{z^2}$ . We favour the latter choice since the half-occupied molecular orbital must be the most strongly antibonding of the set and this is unlikely to have  $d_{z^2}$  symmetry. Our choice of axes for  $[\text{Co}(\text{cp})(\text{CO})_2]^-$  is shown in (I), from which it can be seen that the only strongly  $\sigma$ -antibonding orbital is  $d_{yz}$  ( $1b_1$ ), and we therefore conclude that the electronic configuration on cobalt is . . .  $d_{yz}^1$ , a result in accord with

the calculations of Hofmann on  $[\text{Mn}(\text{cp})(\text{CO})_2]$ .<sup>18</sup> The very small  $g$  shifts and the apparent axial symmetry of the  $g$  tensor show that this orbital is remarkably isolated

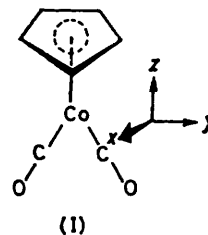

from the remainder, as this structure requires. This also means that we cannot deduce the order of the remaining  $d$  levels from the  $g$  shifts.

**Centre (B).** The structure of centre (B) is less clear cut. The parallel coupling to  $^{59}\text{Co}$  is similar to that of (A) and the limited number of well defined 'perpendicular' features are also similar. We therefore conclude that the electronic structure is still . . .  $d_{yz}^1$  in which case this must also be an electron-gain centre. Since the proton responsible for the hyperfine coupling originates from the hydroxyl group in methanol, we suggest that (B) is formed from (A) by anion protonation. The next problem is to decide on a suitable site for the proton, the choices being the cyclopentadienyl ring, the cobalt atom, or one of the carbonyl ligands. The first should produce a methylene group, in which

case coupling would be expected to two hydrogen nuclei. The second is feasible, but we would have expected to see a larger hyperfine coupling to  $^1\text{H}$  and a greater change in the  $^{59}\text{Co}$  coupling. Protonation of a carbonyl group

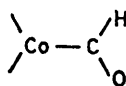

(II)

could occur at carbon to give (II), in which case we can compare the hyperfine coupling with that of the  $\sigma$  radical  $\text{H}\dot{\text{C}}\text{O}$ . This has an isotropic coupling<sup>19</sup> of *ca.* 130 G, so that a coupling of *ca.* 13 G corresponds to a 10% delocalisation onto carbon. We consider this to be the most acceptable structure.

*Centres (C) and (D).* Centre (C) is formed when  $[\text{Co}(\text{cp})(\text{CO})_2]$  is  $\gamma$ -irradiated at 77 K in acetone, and when irradiated solutions in mthf are carefully annealed. Since acetone is a good electron trap, we suggest that (C) is not an electron-excess centre and is therefore probably the parent cation  $[\text{Co}(\text{cp})(\text{CO})_2]^+$ . Curiously, centre (C) was not detected in the irradiated pure material. However, another species (D) was detected, although its features were largely concealed by those of (A). Radical (D) displayed a range of equally spaced 'parallel' features with  $A(^{59}\text{Co}) = 38$  G and  $g$  *ca.* 2.144. If we assume that the lowest- and highest-field features go together, then they comprise a 15-line set indicative of coupling to two equivalent cobalt nuclei. The fact that  $A_{\text{max.}}(\text{D}) = \frac{1}{2}A_{\text{max.}}(\text{C})$  strongly suggests that (D) is a dimeric derivative of (C) and that there has been no major reorganisation of the ligands during the dimerisation.

It is interesting to note that the cation, and not the anion, shows a propensity to bind to one of its neighbouring molecules at low temperatures, despite the high stability of the  $[\{\text{Co}(\text{cp})(\text{CO})_2\}_2]^-$  radical. The inability of the monomer anion to form the dimer in the solid state at low temperature is probably a result of the need to displace two CO ligands, suggesting that no such displacement occurs in the cation dimerisation.

The structure of centre (C) is probably one involving the metal  $d_{zz}$  orbital ( $1b_2$ ). Our results are not compatible with the alternative  $d_{z^2}$  structure since for this we would expect to find that  $A_{\text{max.}}$  would be along the free-spin  $g$ -value direction rather than being linked with a  $g$  value much greater than that of the free spin (Table I). The results are quite satisfactory for  $\dots d_{zz}^1$  with *ca.* 77% of the spin density in this orbital. This conclusion again agrees with Hofmann's orbital scheme for  $[\text{Mn}(\text{cp})(\text{CO})_2]$ .<sup>18</sup>

The results for the dimer anion may be analysed in a similar manner to those of (A), but, because of the large  $g$  value of 2.20, the orbital magnetic contribution to the hyperfine coupling must be subtracted before orbital populations can be calculated. To do this we have used equations<sup>20</sup> (1) and (2). We have averaged the two closely similar  $g$  and  $A$  components to obtain approximate

TABLE 4

Cobalt hyperfine coupling for centre (C) and  $[\{\text{Co}(\text{cp})(\text{CO})_2\}_2]^-$  corrected for spin-orbit coupling effects

Radical	Uncorrected		Corrected		% $d$ character
	$A_{\text{iso.}}/\text{G}$	$2B/\text{G}$	$A_{\text{iso.}}/\text{G}$	$2B/\text{G}$	
(C)	-50	-41	-63.4	-58.8	77.4
$[\{\text{Co}(\text{cp})(\text{CO})_2\}_2]^-$	$\pm 53$	$\pm 24$	$\pm 55.0$	$\pm 36.3$	23.9
	$\pm 1.7$	$\pm 75.3$	$\pm 3.4$	$\pm 103.1$	67.8

'perpendicular' values. The corrected  $A_{\text{iso.}}$  and  $2B$  values are given in Table 4. Since the average  $A$  and

$$A_{\parallel}(\text{exp.}) = A_{\text{iso.}} + 2B(1 - \frac{7}{4}\Delta g_{\parallel} - \frac{3}{4}\Delta g_{\perp}) \quad (1)$$

$$A_{\perp}(\text{exp.}) = A_{\text{iso.}} - B(1 + \frac{11}{4}\Delta g_{\perp}) \quad (2)$$

$g$  values are known from the solution spectrum, there are only two alternative sets of data, with opposite signs, to consider. Choice of positive signs requires the unpaired electron to be in an orbital comprised of the two

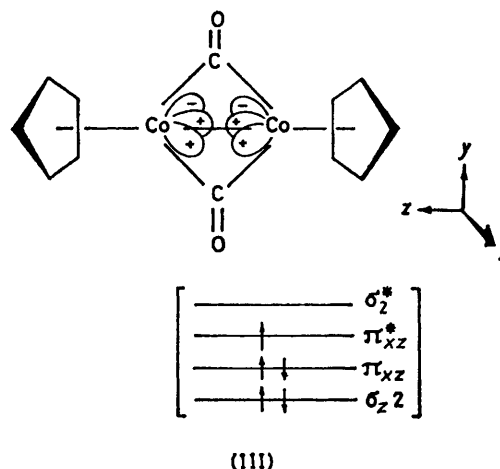

(III)

$d_{z^2}$  orbitals on cobalt, whereas the negative signs would accord with occupancy of the  $d_{xz}$  or  $d_{yz}$  orbitals. The bonding scheme used by Schore *et al.*<sup>9</sup> is shown, with our choice of axes, in (III). This suggests that the major Co-Co bonding involves the  $d_{z^2}(\sigma)$  and  $d_{xz}(\pi)$  orbitals, and places the unpaired electron in the  $(d_{xz}-d_{xz})\pi^*$  orbital. Since  $A_{\parallel}(^{59}\text{Co})$  coincides with the high  $g$  value of 2.20, and since a  $(d_{z^2}-d_{z^2})$  scheme would require this  $g$  value to be close to 2.00, we agree that the  $(d_{z^2}-d_{z^2})^1$  formulation is incorrect.

However, we do not agree that the unpaired electron is necessarily in the  $(d_{xz}-d_{xz})\pi^*$  level. Indeed, if it is, there must have been a dramatic change in the order of levels on going from  $[\text{Co}(\text{cp})(\text{CO})_2]^-$  to  $[\{\text{Co}(\text{cp})(\text{CO})_2\}_2]^-$ , as we have concluded that for the monomeric anion, there is a large energy gap between the  $d_{zz}$  and  $d_{yz}$  orbitals. The fact that  $g_z$  is close to the free-spin value for the dimer anion means that there is still a large gap between  $d_{zz}$  and  $d_{yz}$  since these levels are coupled by  $H_z$ . If the unpaired electron resides in the  $(d_{xz}-d_{yz})\pi^*$  orbital we need to explain why this has become so greatly stabilised relative to the set of levels involving the pair

of  $d_{yz}$  orbitals. One factor is the magnitude of the cobalt-cobalt  $\pi$  bonding. If this is strong then the  $\pi^*(d_{xz}-d_{zz})$  will be destabilised.

Another major factor is the change in the interaction of the bridging carbonyl ligands with the cobalt  $d_{yz}$  orbital. This is purely  $\sigma$  in the monomer, but a mixture of  $\sigma$  and  $\pi$  in the dimer. Admixture of the low-lying  $\pi^*(CO)$  orbital with the  $d_{yz}$  orbitals may lower the antibonding levels sufficiently so that the  $\pi^*(d_{xz}-d_{zz})$  level is uppermost. We conclude that the unpaired electron may be in either a  $d_{yz}$  or  $d_{xz}$  combination on cobalt, but that these levels are greatly separated. Our evidence is insufficient to make a definitive selection. Nevertheless, the estimated total  $d$ -orbital spin density of ca. 75% is high if there is appreciable delocalisation onto the carbonyl groups. Since it is considerably greater than the value of 57% for  $[Co(cp)(CO)_2]^-$ , it lends tentative support to the  $d_{xz}$  assignment where carbonyl participation must be small. This is strongly supported by the absence of detectable hyperfine coupling to  $^{14}N$  in the nitrosyl-substituted dimer, since a relatively large coupling is normally found for NO groups with an unpaired electron in the M-N  $\sigma$  or  $(\sigma + \pi)$  orbitals.<sup>21</sup>

The large positive shift in  $g_y$  shows that the filled  $d_{z^2}$  level is close in energy to the half-occupied level. As can be seen from (III), it might have been expected that coupling to the  $\sigma^*(d_{z^2}-d_{z^2})$  orbital would have dominated and produced a negative contribution to  $\Delta g_y$ . However, for a symmetrical complex, the  $\pi^*$  orbital is only magnetically coupled to the  $\sigma$  level, and no contribution from  $\sigma^*$  is possible.

The small asymmetry in the hyperfine components for the dimer anion probably arises through spin polarisation of inner filled  $d$  electrons. A polarisation of ca. 3% is required but we cannot say definitely which electrons are involved.

We thank the S.R.C. for support, and for a Studentship (to S. W. B.).

[8/1708 Received, 27th September, 1978]

#### REFERENCES

- Part 5, S. W. Bratt and M. C. R. Symons, *J.C.S. Dalton*, 1977, 1314.
- R. B. King, *Inorg. Chem.*, 1966, **5**, 2227.
- V. A. Uchtman and L. F. Dahl, *J. Amer. Chem. Soc.*, 1969, **91**, 3763.
- K. P. C. Vollhardt, J. E. Bercaur, and R. G. Bergman, *J. Amer. Chem. Soc.*, 1974, **96**, 4998.
- K. P. C. Vollhardt, J. E. Bercaur, and R. G. Bergman, *J. Organometallic Chem.*, 1975, **97**, 283.
- W.-S. Lee and H. H. Brintzinger, *J. Organometallic Chem.*, 1977, **127**, 87.
- J. E. Ellis, R. A. Faltnyek, and S. G. Hentges, *J. Organometallic Chem.*, 1976, **120**, 389.
- C. S. Ilenda, N. E. Schore, and R. G. Bergman, *J. Amer. Chem. Soc.*, 1976, **98**, 255.
- N. E. Schore, C. S. Ilenda, and R. G. Bergman, *J. Amer. Chem. Soc.*, 1976, **98**, 256.
- N. E. Schore, C. S. Ilenda, and R. G. Bergman, *J. Amer. Chem. Soc.*, 1977, **99**, 1781.
- J. Müller and S. Schmitt, *J. Organometallic Chem.*, 1975, **97**, C54.
- W. A. Herrmann and I. Bernal, *Angew. Chem. Internat. Edn.*, 1977, **16**, 172.
- I. Bernal, J. D. Korp, G. M. Reisner, and W. A. Herrmann, *J. Organometallic Chem.*, 1977, **139**, 321.
- R. R. Corderman and J. L. Beauchamp, *Inorg. Chem.*, 1977, **16**, 3135.
- J. A. Brivati, J. M. Gross, M. C. R. Symons, and D. J. A. Tinling, *J. Chem. Soc.*, 1965, 6504.
- S. W. Bratt and M. C. R. Symons, unpublished work.
- C. Froese, *J. Chem. Phys.*, 1966, **45**, 1417; B. A. Goodman and J. B. Raynor, *Adv. Inorg. Chem. Radiochem.*, 1970, **13**, 135; M. C. R. Symons, 'Chemical and Biochemical Aspects of Electron Spin Resonance Spectroscopy,' Van Nostrand-Reinhold, London, 1978.
- P. Hofmann, *Angew. Chem. Internat. Edn.*, 1977, **16**, 536.
- E. L. Cochran, F. J. Adrian, and V. A. Bowers, *J. Chem. Phys.*, 1962, **36**, 1661.
- A. Abragam and B. Bleaney, 'Electron Paramagnetic Resonance of Transition Ions,' Oxford University Press, London, 1970.
- B. A. Goodman, D. A. C. McNeil, J. B. Raynor, and M. C. R. Symons, *J. Chem. Soc. (A)*, 1966, 1547.